

**SM SERIES**

DIMENSIONS (Unless otherwise specified, a tolerance of ±0.4 mm applies to all dimensions.)

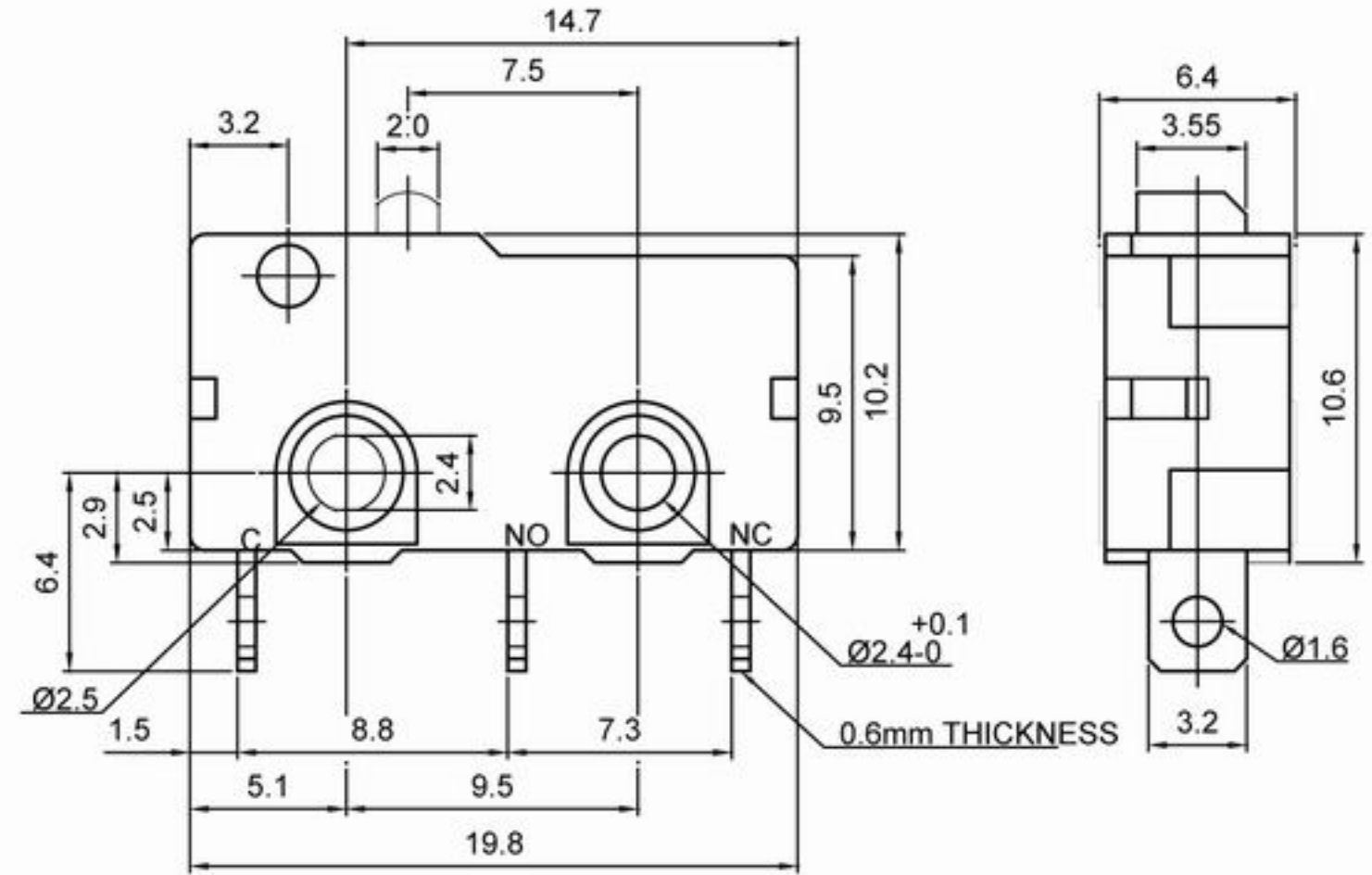

**SPECIFICATIONS**

- Contact Resistance (initial).....Max. 300mΩ
- Insulation Resistance (at 500VDC/minute).....Min. 100MΩ
- Dielectric Strength..... 1000VAC (50~60Hz)
- Storage Temperature Range..... -25°C to 85°C
- Storage Humidity.....at 40°C, Max. 85% R.H
- Operating Temperature range ..... -40°C to 125°C
- Vibration.....10~55Hz, displacement 0.75mm (p-p)
- Electrical Service Life.....0.1A - Min. 1,000,000 operations  
Other rating - Min. 6,000 operations
- Electrical Operating Frequency ....0.1A - 120 operations per minute  
Other rating - 10~30 operations per minute
- Mechanical Service Life.....Min. 10,000,000 operations
- Mechanical Operating Frequency.....120 operations per minute

**CONTACT CONFIGURATION**

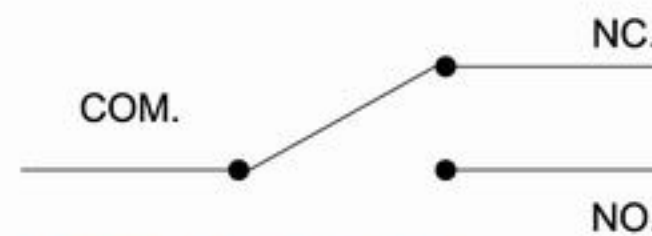

**APPLICATION**

Telephone, Air conditioner, Computer, Humidifier, Alarm, Time recorder, Mixer & Chopper, Solder gun, Neon phone, Fax machine, Joystick, Water pump, Gas detector, Pencil sharpener, Money sorter, Food processor, Electric knife, Toy car, Juicer, Electric steak pan.

**CERTIFICATE INFORMATION**

Model Name	UL	CSA	ENEC14
SM-P1 SM-G1	0.1A 125/250VAC 0.1A 30VDC (Temp:120°C) Min. 10,000 operations	0.1A 125/250VAC 0.1A 30VDC Min. 6,000 operations	Non
SM-G5	5A 125/250VAC (Temp:120°C) Min. 10,000 operations	5A 125/250VAC/30VDC Min. 6,000 operations	Non
SM-05	5A 125/250VAC (Temp:120°C) Min. 10,000 operations	5A 125/250VAC/30VDC Min. 6,000 operations	5A 125/250VAC,u40T125 1E4 ( Only for H, Q, T force
SM-10	10.1A 125/250VAC Min. 6,000 operations 5A 125/250VAC (Temp:120°C) Min. 100,000 operations	Non	Non



## THE SELECTION OF RATING & FORCE

MODEL	RATING	D	L	S	H	Q	T
SM	0.1A	*	*	*	*	*	*
	5A		*	*	*	*	*
	10.1A				*	*	*

THE Symbol "\*" to represent the result is accept

## TERMINAL TYPES (The thickness of each terminal is 0.6)

Solder terminal A TYPE	Quick connect terminal B TYPE (#110)	Side PCB terminal C TYPE	Side PCB terminal D TYPE
Side PCB terminal E TYPE	PCB terminal P TYPE	<b>MOUNTING HOLES</b> (For PCB Terminal)	

## ORDERING INFORMATION

S	M	0	5	S	0	3	P	0	Z							
SERIES PREFIX	CODE	RATING CURRENT		CODE	OPERATING FORCE		CODE	ACTUATOR TYPE		CODE	TERMINAL TYPE		CODE	CIRCUIT ARRANGEMENT		ROHS CODE
	P1	0.1A 30VDC 0.1A 125/250VAC		T	MAX HEAVIER		00			A			0	S.P.D.T.		
	05	5A 125/250VAC		Q	HEAVIER		01			B			1	S.P.S.T. NO		
	10	10.1A 125/250VAC		H	HEAVY		02			C			2	S.P.S.T. NC		
				S	STANDARD		03			D						
				L	LIGHT		04			E						
				D	SLIGHT		05			P						
							06									
							07									
							08									
							09									

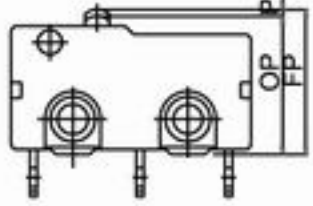
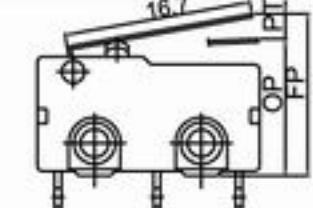
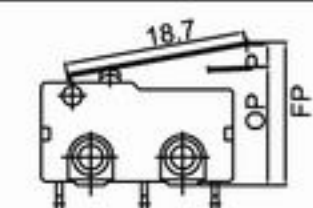
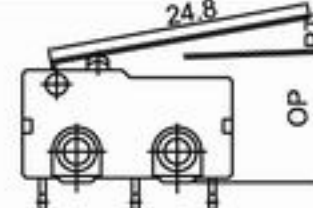
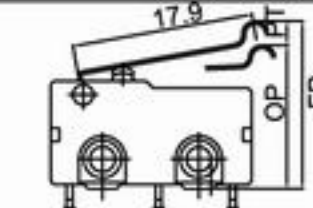
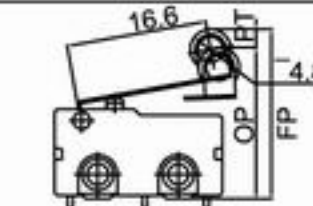
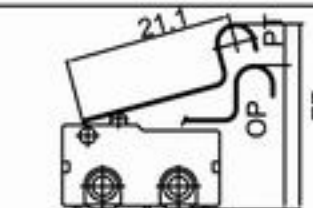
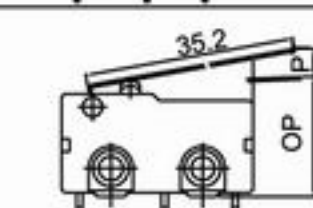
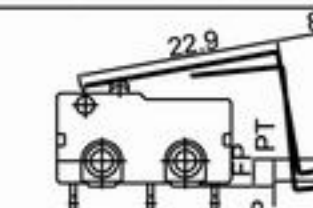
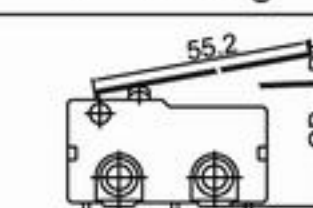

## ORDERING CHARACTERISTICS

SWITCH TYPE	PART SUFFIX	OF MAX. (gf)	OP (mm)	PT MAX. (mm)	OT Min. (mm)	MD MAX. (mm)	FP MAX. (mm)	RF Min. (gf)
SM□□□-00□□-Z		H 249	11.4±0.3	1.1	0.4	0.2	12.2	50
		S 146						35
		L 104						20
SM□□□-01□□-Z		H 60	11.8±0.8	3.6	0.6	0.8	14.6	15
		S 35						10
		L 25						6
SM□□□-02□□-Z		H 55	11.8±0.9	4.0	0.6	0.8	14.9	13
		S 33						8
		L 25						6
SM□□□-03□□-Z		H 45	11.8±1.5	6.1	0.8	1.5	16.4	9
		S 25						6
		L 20						5
SM□□□-04□□-Z		H 56	13.7±1.0	4.6	0.8	0.8	17.3	9
		S 34						8
		L 25						5
SM□□□-05□□-Z		H 60	17.5±0.8	3.8	0.8	0.8	20.5	15
		S 35						8
		L 25						6
SM□□□-06□□-Z		H 48	19.0±1.5	5.7	1.0	1.0	23.2	10
		S 28						6
		L 20						4
SM□□□-07□□-Z		H 30	11.8±2.0	8.6	1.5	1.8	18.4	7
		S 20						4
		L 15						2
SM□□□-08□□-Z		H 30	-2.3±3.0	6.0	1.0	1.9	5.4	3
		S 20						4
		L 15						2
SM□□□-09□□-Z		H 18	11.8±3.0	13.3	1.0	2.9	22.1	4
		S 12						2.5
		L 8						1.5